



US007211062B2

(12) **United States Patent**  
**Kwon**

(10) **Patent No.:** **US 7,211,062 B2**  
(45) **Date of Patent:** **May 1, 2007**

(54) **SOLID SOLUTION PERFORATOR FOR DRUG DELIVERY AND OTHER APPLICATIONS**

(75) Inventor: **Sung-Yun Kwon**, Fremont, CA (US)

(73) Assignee: **TheraJect, Inc.**, Fremont, CA (US)

(\*) Notice: Subject to any disclaimer, the term of this patent is extended or adjusted under 35 U.S.C. 154(b) by 80 days.

3,814,097 A	6/1974	Ganderton et al.	128/268
3,964,482 A	6/1976	Gerstel et al.	
4,109,655 A	8/1978	Chacornac	
4,592,753 A	6/1986	Panoz	
4,798,582 A	1/1989	Sarath et al.	
4,936,835 A	6/1990	Haaga	
5,250,023 A *	10/1993	Lee et al.	604/20
5,262,128 A	11/1993	Leighton et al.	
5,279,544 A	1/1994	Gross et al.	
5,383,512 A	1/1995	Jarvis	

(Continued)

**FOREIGN PATENT DOCUMENTS**

JP 2003-238347 8/2003

(Continued)

*Primary Examiner*—Catherine S. Williams  
(74) *Attorney, Agent, or Firm*—Robins & Pasternak LLP

(21) Appl. No.: **10/767,359**

(22) Filed: **Jan. 28, 2004**

(65) **Prior Publication Data**

US 2004/0199103 A1 Oct. 7, 2004

**Related U.S. Application Data**

(63) Continuation of application No. 10/179,749, filed on Jun. 25, 2002, now Pat. No. 6,945,952.

(51) **Int. Cl.**

*A61M 37/00* (2006.01)

*A61B 17/20* (2006.01)

(52) **U.S. Cl.** ..... **604/46**; 604/48; 604/890.1; 604/173; 604/272; 424/426

(58) **Field of Classification Search** ..... 604/46, 604/60, 890.1, 47, 506, 93.01, 117, 180, 131-147, 604/173-174, 181-182, 185, 187, 218, 239, 604/272-274, 48, 82-85; 424/426, 449, 424/448, 423, 400, 422

See application file for complete search history.

(56) **References Cited**

**U.S. PATENT DOCUMENTS**

3,596,660 A \* 8/1971 Melone ..... 604/47

(57) **ABSTRACT**

A solid drug perforator (SSP) system and an associated drug reservoir are provided for delivering therapeutic, prophylactic and/or cosmetic compounds, for nutrient delivery and for drug targeting. For drug delivery, the SSP system includes an active drug ingredient and a matrix of perforator material that biodegrades or dissolves quickly upon contact with a patient's body. The SSP system provides a skin barrier perforator and a controller for prompt initiation and cut-off of drug delivery. In a preferred method of transdermal drug delivery, an SSP system containing a selected drug penetrates into an epidermis or dermis, and the drug is promptly released from the (dissolving) SSP system perforator. An additional drug is optionally delivered from a patch reservoir through skin pores created by insertion of the perforator. Formulation and fabrication procedures for the SSP and associated reservoir are also provided. An SSP system can be fabricated with variety of shapes and dimensions.

**13 Claims, 4 Drawing Sheets**

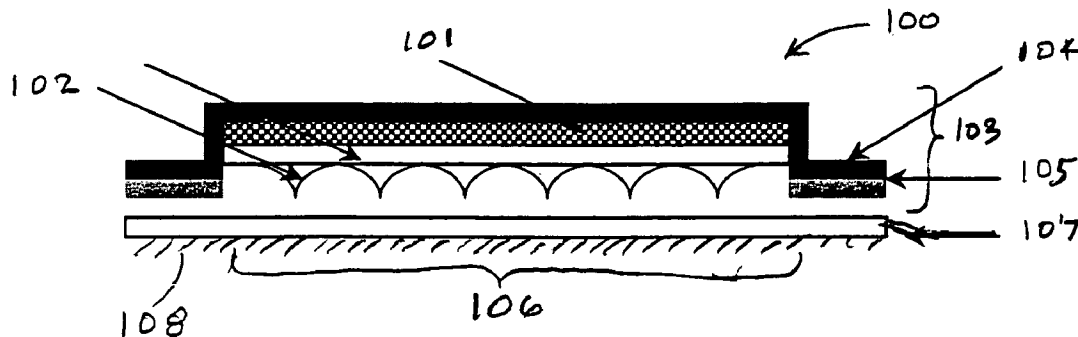

U.S. PATENT DOCUMENTS

5,445,611 A 8/1995 Eppstein et al.  
 5,457,041 A 10/1995 Ginaven et al.  
 5,458,140 A 10/1995 Eppstein et al.  
 5,527,288 A 6/1996 Gross et al.  
 5,591,139 A 1/1997 Lin et al.  
 5,749,376 A \* 5/1998 Wilk et al. .... 128/898  
 5,843,114 A 12/1998 Jang  
 5,848,991 A 12/1998 Gross et al.  
 5,855,211 A 1/1999 Nelson  
 5,855,801 A 1/1999 Lin et al.  
 5,879,326 A 3/1999 Godshall et al.  
 5,928,207 A 7/1999 Pisano et al.  
 5,983,136 A 11/1999 Kamen  
 6,013,050 A 1/2000 Bellhouse et al.  
 6,030,404 A 2/2000 Lawson et al.  
 6,050,988 A 4/2000 Zuck  
 6,083,196 A 7/2000 Trautman et al.  
 6,091,975 A 7/2000 Daddona et al.  
 6,102,896 A 8/2000 Roser  
 6,106,751 A 8/2000 Talbot et al.  
 6,132,755 A 10/2000 Eicher et al.  
 6,142,939 A 11/2000 Eppstein et al.  
 6,187,210 B1 2/2001 Leboutitz et al.  
 6,219,574 B1 4/2001 Cormier et al.  
 6,230,051 B1 5/2001 Cormier et al.  
 6,256,533 B1 7/2001 Yuzhakov et al.  
 6,312,612 B1 11/2001 Sherman et al.  
 6,322,808 B1 11/2001 Trautman et al.  
 6,331,266 B1 12/2001 Powell et al.

6,331,310 B1 12/2001 Roser et al.  
 6,334,856 B1 \* 1/2002 Allen et al. .... 604/191  
 6,352,506 B1 3/2002 Eppstein et al.  
 6,352,722 B1 3/2002 Blair  
 6,375,776 B1 4/2002 Buoni et al.  
 6,379,324 B1 4/2002 Gartstein et al.  
 6,406,455 B1 6/2002 Willis et al.  
 6,440,096 B1 \* 8/2002 Lastovich et al. .... 604/27  
 6,485,453 B1 11/2002 Buch-Rasmussen et al.  
 6,532,386 B2 \* 3/2003 Sun et al. .... 604/20  
 6,611,707 B1 \* 8/2003 Prausnitz et al. .... 604/21  
 6,656,147 B1 \* 12/2003 Gertsek et al. .... 604/28  
 6,743,211 B1 \* 6/2004 Prausnitz et al. .... 604/239  
 2001/0038858 A1 11/2001 Roder et al.  
 2001/0053891 A1 12/2001 Ackely  
 2002/0006355 A1 1/2002 Whitson  
 2002/0009464 A1 1/2002 Colaco  
 2002/0012687 A1 1/2002 Roser et al.  
 2002/0016562 A1 2/2002 Cormier et al.  
 2002/0020688 A1 2/2002 Sherman et al.  
 2002/0058067 A1 5/2002 Blair  
 2002/0082543 A1 \* 6/2002 Park et al. .... 604/21  
 2002/0110585 A1 8/2002 Godbey  
 2002/0146540 A1 10/2002 Johnston et al.  
 2005/0065463 A1 3/2005 Tobinaga et al. .... 604/46

FOREIGN PATENT DOCUMENTS

JP 2003238347 8/2003

\* cited by examiner

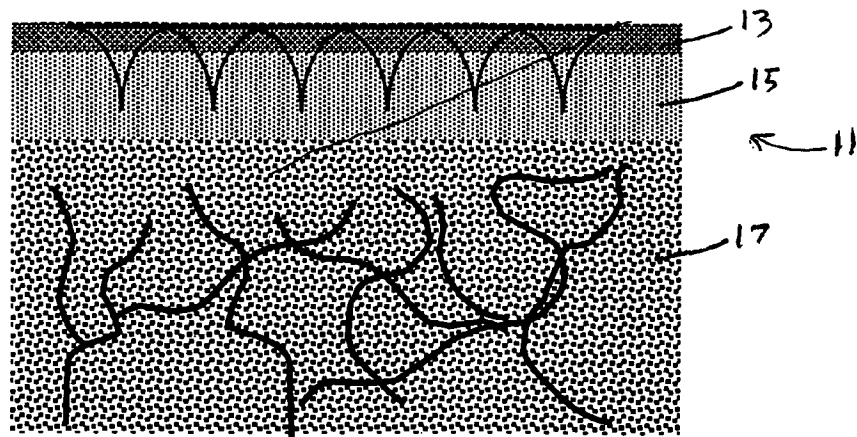

FIG. 1

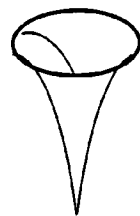

FIG. 2A

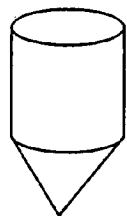

FIG. 2B

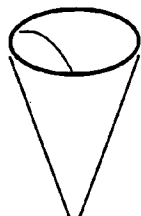

FIG. 2C

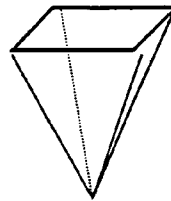

FIG. 2D

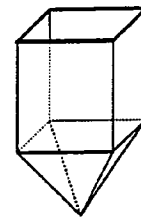

FIG. 2E

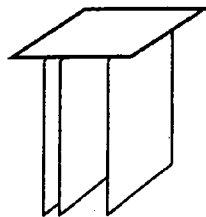

FIG. 2F

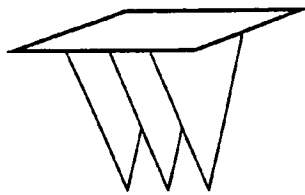

FIG. 2G

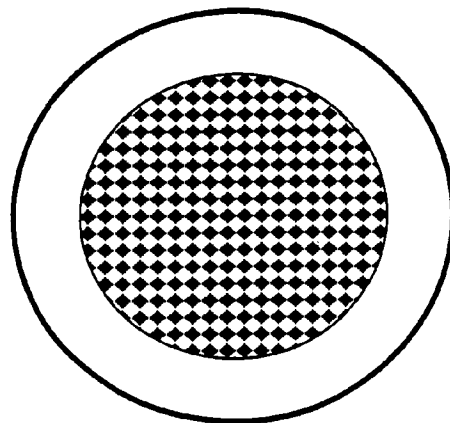
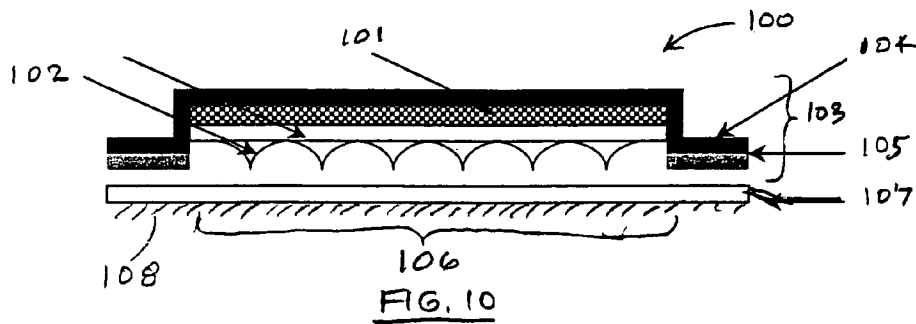
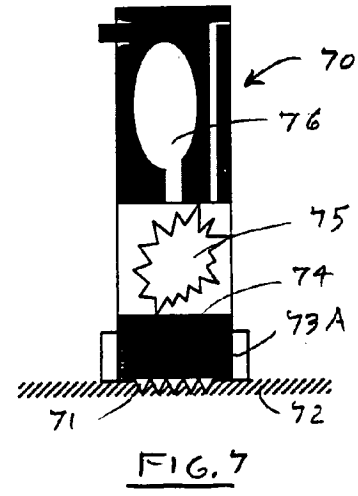
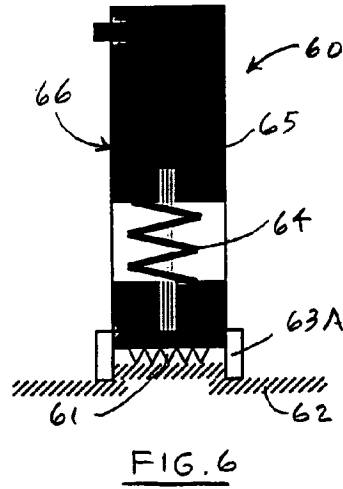
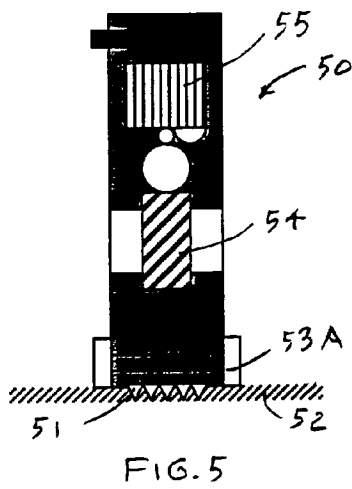
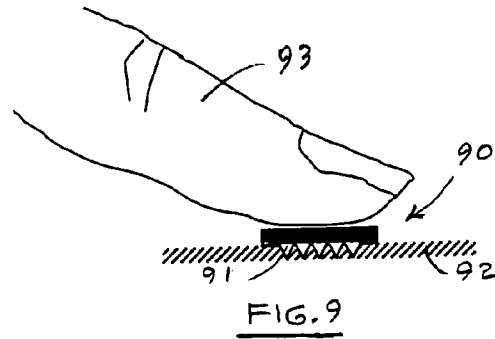
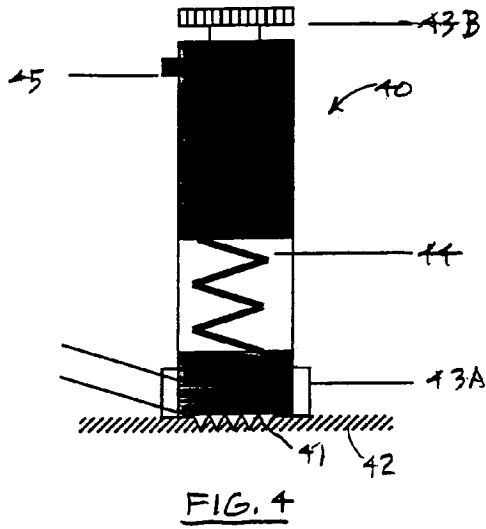

FIG. 3



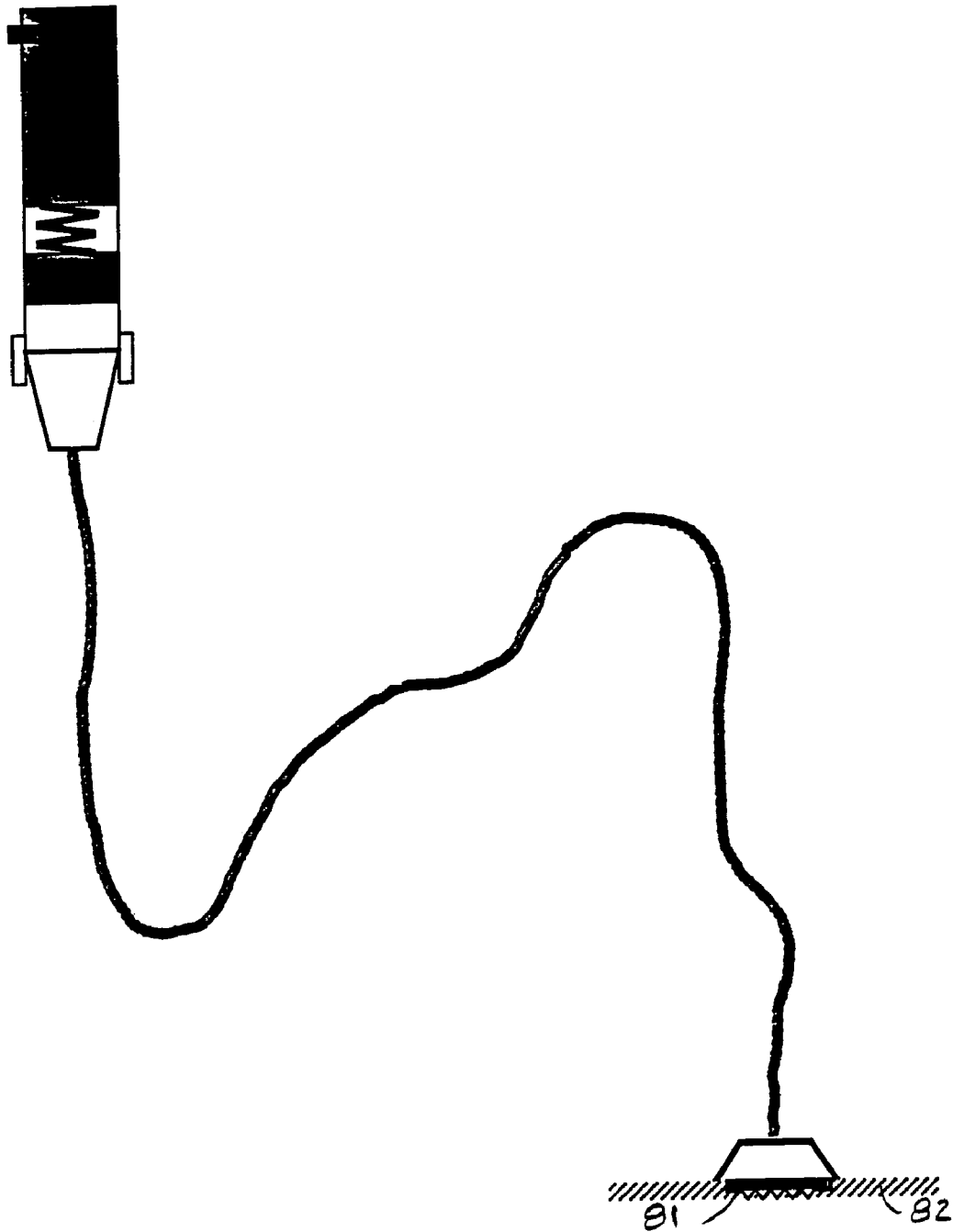

FIG. 8

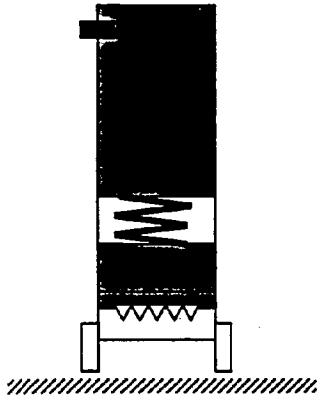

FIG. 11A

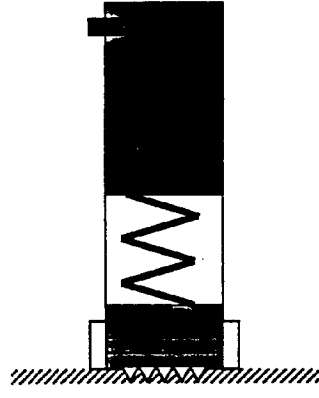

FIG. 11B

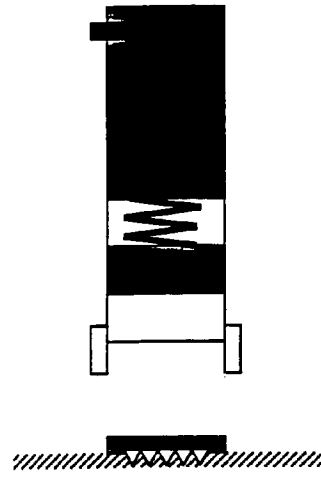

FIG. 11C



FIG. 12A



FIG. 12D



FIG. 12B

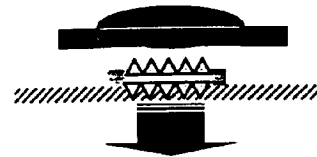

FIG. 12E

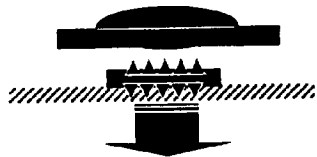

FIG. 12C



FIG. 12F

1

## SOLID SOLUTION PERFORATOR FOR DRUG DELIVERY AND OTHER APPLICATIONS

This application is a continuation of U.S. application Ser. No. 10/179,749 filed on Jun. 25, 2002, now U.S. Pat. No. 6,945,952 and claims priority therefrom pursuant to 35 U.S.C. §120.

### FIELD OF THE INVENTION

This invention relates to controlled delivery of one or more drugs to, and diagnosis of fluids in, a patient's body.

### BACKGROUND OF THE INVENTION

Many new drugs, including proteins, peptides and DNA constituents, have been developed for better and more efficient treatment for disease and illness. Especially due to recent advances in molecular biology and biotechnology, increasingly potent pharmaceutical agents, such as recombinant human insulin, growth hormone and erythropoietin are available. However, a major limitation in using these new drugs is lack of an efficient drug delivery system; a drug must be transported across one or more biological barriers in the body at rates and in amounts that are therapeutically effective.

Most drugs are orally administered. However, some drugs, especially protein and peptide drugs, cannot be effectively adsorbed in this manner because of severe degradation in the gastrointestinal tract, poor absorption in intestinal membrane and/or first pass breakdown by the liver.

Another administration technique is parental injection, using standard syringes or catheters. Needle injection provokes needle phobia, substantial pain, local damage to the skin in many patients. Withdrawal of body fluids, such as blood, for diagnostic purposes provokes similar discomforts. Further, needle injection is not ideal for continuous delivery of a drug, or for continuous diagnosis.

Another drug delivery technique is transdermal delivery, which usually relies on diffusion of a drug across the skin. This method is not broadly applicable because of the poor skin permeability of many drugs. The outermost layer of skin, stratum corneum, represents a major barrier to transdermal drug penetration. Once a drug reaches the dermal depth (below the epidermal layer), the drug diffuses rapidly to deep tissue layers and other parts of the system via blood circulation.

In an attempt to improve the rate of drug delivery through the skin, chemical enhancers, iontophoresis, electroporation, ultrasound, and heat elements have been used to supplement drug delivery. However, these techniques are not suitable for some types of drugs and often fail to provide a therapeutic level of delivery. These techniques sometimes result in undesirable skin reactions and/or are impractical for continuous controlled drug delivery over a period of hours or days.

Other attempts, such as particle or liquid injection, have been made to design alternative techniques to transfer drugs transdermally. A main advantage of those techniques is absence of needle use and reduction of incidence of contamination. However, liquid injection frequently causes some pain and/or sub-dermal hemorrhage. One technique, ballistic particle injection, is hard to administer exactly and continuously and can cause micro-bleeding.

Other attempts, such as micro-needle drug delivery, have been developed using micro-fabrication procedures from the

2

semiconductor industry. While the conventional devices have some uses, most of these devices are designed for drug delivery through a hollow interior of a needle or along an outer surface of a needle. However, because most of these needles are made from brittle silicon materials, needle breakage under the skin is a possibility. Some devices are used as skin perforators for subsequent patch drug application. There remains a need for better drug delivery devices that rely on smaller incisions, deliver drug with greater efficiency and less variability of drug administration, and/or are easier and safer for a patient to use.

What is needed is an approach that reduces or controls the skin barriers to permit controlled introduction of one, two or more drugs, simultaneously or sequentially, and to provide prompt initiation and cut-off of drug delivery with improved efficiency and safety.

### SUMMARY OF THE INVENTION

These needs are met by the invention, which applies mechanical penetration of the skin, using a solid solution perforator ("SSP") system including an array of one or more needles, blades or other perforators that include a drug as part of a solid solution perforator and dissolve or undergo biodegradation relatively quickly. An "SSP device" optionally includes a reservoir of a second drug, contained in a patch, located adjacent to the perforator array and containing either the same drug as is contained in the SSP system perforators or a different drug. By creating a drug transport channel or port in the skin, especially in the outermost layer, through use of an SSP (system) perforator, the barrier properties of skin can be diminished or controlled for drug delivery and for providing access to body fluids to be monitored. Optionally, a patch includes a ring of adhesive that bonds with, and holds the reservoir against, the patient's skin adjacent to the perforated region of the skin. The patch system is separately activated to deliver the second drug through the skin channels(s) formed by the SSP perforator (s).

In contrast to conventional hollow needle technologies, the SSP system includes a solid matrix of dissolvable (including meltable) or biodegradable material that optionally holds one or more selected drugs and is formed into one or more perforators. The matrix can be composed of fast-dissolving and/or swelling materials. For drug delivery application, the SSP system includes an active drug that dissolves reasonably quickly and leaves the channel open for subsequent drug delivery, or to collect and monitor body fluids or other analytes. An SSP perforator can be 100 percent drug or a mixture of drugs, depending upon the application and physical/chemical properties of the drug(s). Inclusion of a swelling component in the matrix can keep the channel open even longer. The solid solution can be a homogeneous or non-homogeneous phase or porous solid solution, for example, a solid made from an emulsion or suspension.

### BRIEF DESCRIPTION OF THE DRAWINGS

FIG. 1 is a schematic cross-section of a patient's skin. FIGS. 2A-2G are perspective views of examples of suitable SSP perforators that can be used in the invention. FIG. 3 is a plan view of an array of perforators and a surrounding annular ring of adhesive that are part of an SSP system. FIGS. 4-9 illustrate activation mechanisms that can be used for SSP skin penetration according to the invention.



FIG. 10 illustrates a drug reservoir system according to the invention.

FIGS. 11A–11C and 12A–12F illustrate operation of patch systems that can be used as part of the invention.

#### DESCRIPTION OF BEST MODES OF THE INVENTION

FIG. 1 is a cross-sectional view of the top layers of the skin 11, including a stratum corneum 13, an epidermal layer or epidermis 15 and a dermal layer or dermis 17. The outermost layer of skin, the stratum corneum 13, is a dead cell layer, usually between 10 and 20 microns ( $\mu\text{m}$ ) thick. The stratum corneum 13 contains hydrophilic keratinocytes surrounded by a hydrophobic extra-cellular matrix of lipids, mainly ceramide. Due to the structural and compositional uniqueness, the stratum corneum 13 presents the greatest barrier to transdermal flux of drugs or other molecules into the body, and of body fluids and other analytes out of the body. The stratum corneum 13 is continuously renewed by shedding of corneum cells, with an average turnover time of 2–3 weeks.

Below the stratum corneum 13 is the viable epidermis or epidermal layer 15, which is between 50 and 100  $\mu\text{m}$  thick. The epidermis contains no blood vessels and freely exchanges metabolites by diffusion to and from the dermis 17, located immediately below the epidermis 15. The dermis is between 1 and 3 mm thick and contains blood vessels, lymphatics, and nerves. Once a drug reaches the dermal layer, the drug will perfuse through system circulation.

An SSP system includes one or more SSP drug perforators, preferably at least 20–200 in an area of about 1  $\text{cm}^2$ , at least one or which is formed as a solid matrix of one or more needles or blades, each pointed or sharpened at a first end for perforation of the skin. Each perforator is strong and intact enough to pierce the stratum corneum, and is either biodegradable or dissolvable when the perforator (and drug) has penetrated into the patient's body with body fluid and/or solvent in the drug reservoir. The biodegradation or dissolution process may occur over a time interval of between a few tens of seconds and a few hours, with preference being given to shorter time intervals. FIGS. 2A–2G are perspective views of individual matrix shapes that are suitable for use with an SSP system. The matrix in FIG. 2A is a cone with a cusp-like point that may provide extra penetration power. The matrix in FIG. 2B is a conventional cone shape with a conventional linear penetration point. The matrices in FIGS. 2C and 2D are cylinder-plus-cone shape for a circular cylinder and for a rectangular (or, more generally, polygonal) cylinder, respectively. The matrix in FIG. 2E is a polygonal cone shape. The matrices in FIGS. 2F and 2G provide sequences of one or more sharp or slicing blades (straight or serrated) that contact and penetrate the skin. Other shapes with a pointed or blade end can also be used here. The SSP (system) perforators illustrated in FIGS. 2A–2G have various shapes and include the solid matrix material and the selected (first) drug within the matrix material (interstitially distributed or otherwise).

The SSP perforators can have straight or tapered shafts or can be pyramids or wedges or blades, as illustrated in FIGS. 2A–2G. In a preferred embodiment, the outer diameter of an SSP perforator is greatest at the base or second end, about 1–1000  $\mu\text{m}$ , and the perforator outer diameter near the first end is preferably 10–100  $\mu\text{m}$ . The length of an SSP perforator is typically in a range of 1–2000  $\mu\text{m}$ , more preferably in a range of 100–1000  $\mu\text{m}$ . The skin is not a smooth and rugged surface and has different depths microscopically. In

addition, the thickness of the stratum corneum and elasticity of the skin varies from person to person and from location to location on any given person's body. A desirable penetration depth has a range, rather than a single value, for effective drug delivery and relatively painless and bloodless penetration. Penetration depth of an SSP perforator can affect pain as well as delivery efficiency. In transdermal applications, the "penetrated depth" of the SSP perforator is preferably less than 100  $\mu\text{m}$  so that a perforator, inserted into the skin through the stratum corneum, does not penetrate past the epidermis. This is an optimal approach to avoid contacting nerves and blood vessels. In such applications, the actual length of the SSP perforator can be longer because the basal layer associated with the SSP system may not be fully inserted into the skin because of elasticity and rough surface of the skin.

However, depending upon medical needs, perforator penetration to the dermis may be required in some applications. In these instances, use of a SSP system can be a practical option in handling instant drug delivery situations. The penetrating portion of an SSP perforator can be optimized by adjusting perforator variables (SSP length, dimension, mechanical properties of basal or substrate layer as well as stroke and speed of insertion of an SSP perforator), as well as accounting for target skin elasticity, skin hardness and surface roughness.

A basal layer (shown in FIGS. 3 and 10) provides protection to isolate a perforated skin region from contamination, and the basal layer can contain anti-bacterial agents and can create occlusion to hydrate perforated skin to enhance flux of fluids. A portal channel likely will contract or expand depending on the perforator material properties after the SSP perforator dissolves or swells.

The primary functions of an SSP perforator are to pierce the stratum corneum, to provide prompt initiation and cut-off of drug delivery, and optionally to help keep the channel open for subsequent drug delivery or body fluid monitoring. As long as an SSP perforator dissolves reasonably quickly and is strong enough to pierce the stratum corneum, any biocompatible material can serve as an SSP perforator.

In preparing an SSP perforator, a mold is prepared using precision machining, micro-machining (such as MEMS), or laser-based or electro-discharge machining. When the mold is prepared, a liquid solution, including the matrix material and including the selected drug(s), is cast in the mold and dried. Depending on the viscosity and other physical and chemical properties of the liquid solution, additional force such as centrifuge force or compression force may be needed to fill the mold. To form a solid solution, the solvent needs to be air-dried, vacuum-dried or freeze-dried. Once a solid solution is formed, an SSP perforator is separated from the mold and cut to an appropriate shape and size.

Where a powder form is used for the SSP material, a mixed powder is spread over the mold. Depending upon the chemical and physical properties of the powder, appropriate heating of the powder may be applied to melt or insert viscous materials into the mold. Alternatively, the powder may be inserted into the mold by pressure and/or application of heating, with or without use of binding agents. When SSP perforators have been formed into an array, the SSP array is cooled, separated from the mold, and incorporated into an SSP system.

Another suitable approach for SSP fabrication is photo-cross linking. A polymer solution including a photo-initiator is cast on the mold and is solidified by irradiation. Once the solution is solidified, the solid solution can be peeled off and cut and shaped to appropriate size. Another feasible



5

approach for making perforators is fabrication of a plurality of micro-fibers that are spooled, arrayed and combined in a plunger.

Suitable matrix materials for an SSP perforator include polymers, including but not limited to polyvinylpyrrolidone (PVP), polyethylene glycol (PEG), polyvinyl alcohol (PVA), cellulose, hydroxypropyl cellulose (HPC), hydroxyethyl cellulose (HEC), hydroxypropyl methylcellulose (HPMC), dextrin, mono- and polysaccharide, sodium carboxymethyl cellulose, polyalcohol, gelatin, gum arabic, alginate, chitosan cyclodextrin and other biopolymers.

Carbohydrate derivatives, such as sugar derivatives (trehalose, glucose, maltose, lactose, maltulose, iso-maltulose, lactulose, fructose, turanose, melitose, melezitose, dextran, maltotol, sorbitol, xylitol, palatinit and mannitol) can be used. Water-soluble ingredients, such as phosphate, nitrate and carboxylate glasses, magnesium chloride, potassium chloride and calcium chloride can be also used for a matrix material, alone or mixed with a matrix polymer.

Other examples of suitable matrix materials include non-ionic hydrophilic or ionic surfactants or lipophilic additives selected from among alkylglucosides, alkylmaltosides, alkylthioglucosides, lauryl macroglycerides, polyoxyethylene alkyl ethers, polyoxyethylene alkylphenols, polyethylene glycol fatty acids esters, polyethylene glycol glycerol fatty acid esters, polyoxyethylene sorbitan fatty acid esters, polyoxyethylene-polyoxypropylene block copolymers, polyglycerol fatty acid esters, polyoxyethylene glycerides, polyoxyethylene sterols, derivatives, and analogues thereof, polyoxyethylene vegetable oils, polyoxyethylene hydrogenated vegetable oils, reaction mixtures of polyols and at least one member of the group consisting of fatty acids, glycerides, vegetable oils, hydrogenated vegetable oils, and sterols, tocopherol polyethylene glycol succinates, sugar esters, sugar ethers; sucroglycerides, and mixtures thereof.

An ionic surfactant may be selected from among alkyl ammonium salts; bile acids and salts, analogues, and derivatives thereof; fatty acid derivatives of amino acids, carnitines, oligopeptides, and polypeptides; glyceride derivatives of amino acids, oligopeptides, and polypeptides; acyl lactylates; mono-diacetylated tartaric acid esters of mono-diglycerides; succinylated monoglycerides; citric acid esters of mono-diglycerides; alginate salts; propylene glycol alginate; lecithins and hydrogenated lecithins; lysolecithin and hydrogenated lysolecithins; lysophospholipids and derivatives thereof; phospholipids and derivatives thereof; salts of alkylsulfates; salts of fatty acids; sodium docusate; and mixtures thereof.

A lipophilic additive is selected from among alcohols, polyoxyethylene alkylethers, fatty acids, bile acids, glycerol fatty acid esters, acetylated glycerol fatty acid esters, lower alcohol fatty acids esters, polyethylene glycol fatty acids esters; polyethylene glycol glycerol fatty acid esters, polypropylene glycol fatty acid esters, polyoxyethylene glycerides, lactic acid derivatives of mono/diglycerides, propylene glycol diglycerides, sorbitan fatty acid esters, polyoxyethylene sorbitan fatty acid esters, polyoxyethylene-polyoxypropylene block copolymers, transesterified vegetable oils, sterols, sterol derivatives, sugar esters, sugar ethers, sucroglycerides, polyoxyethylene vegetable oils, polyoxyethylene hydrogenated vegetable oils, reaction mixtures of polyols and at least one member of the group consisting of fatty acids, glycerides, vegetable oils, hydrogenated vegetable oils, and sterols, and mixtures thereof.

FIG. 3 is a plan view of a patch system formed over an array of SSP perforators 31 that are optionally surrounded by a basal layer including an annular region 33 containing

6

adhesive and an anti-bacterial agent (optional), to isolate the perforation region from other regions on the patient's skin. The annular region 33 of adhesive is intended to hold the SSP system to the skin and to prevent, or reduce the likelihood of, entry of foreign matter and/or external infection. Optionally, a drug reservoir (not shown in FIG. 3) may be located above the SSP perforator array 31 and/or may also be enclosed by the annular region 33 of adhesive.

FIG. 4 is a sectional side view illustrating a perforation activation mechanism 40 that causes one or more SSP perforators 41 to penetrate, or withdraw from, the patient's skin 42 to initiate and/or cut off delivery of a drug contained in the perforator(s). Initiation or cut off of drug delivery can occur in as little as about 5 minutes, by insertion or removal of the SSP perforator(s) 41. Depth of perforator penetration is adjusted by a perforation adjustment mechanism, 43A and 43B (optional), such as a knob or screw. An SSP perforator 41 is driven into the patient's skin 42 by a spring or similar mechanism 44 that is controlled by a perforation mechanism trigger 45.

FIG. 5 is a sectional side view illustrating a perforation activation mechanism 50 in which one or more SSP perforators 51 is driven into, or withdrawn from, the patient's skin 52 by a screw 54 that is controlled by a screw knob or motor or similar device 55.

FIG. 6 is a sectional side view illustrating a perforation activation mechanism 60 in which one or more SSP perforators 61 is urged into the patient's skin 62 by a vacuum device 65, then injected by a spring 64 that causes the perforators 61 to be extended from, or withdrawn into, an activation housing 66. Application of a mild vacuum in the skin perforation region may help to reduce skin variability.

FIG. 7 is a sectional side view illustrating a perforation activation mechanism 70 in which one or more SSP perforators 71 is driven into, or withdrawn from, the patient's skin 72 by a gas expansion mechanism 74 including a gas pressure chamber 75 and a gas reservoir 76.

FIG. 8 illustrates one means by which the perforator mechanisms shown in FIGS. 4, 5, 6 and/or 7 may be used to control or vary movement, including but not limited to penetration depth, of the corresponding SSP perforators 82 into or out of the patient's skin 81. This design can be used with laparoscopes or endoscopes for internal drug delivery.

FIG. 9 is a sectional side view illustrating a perforation activation mechanism 90 in which one or more SSP perforators 91 is driven into the patient's skin 92 by pressure, manually applied by a finger or other pressure mechanism 93, to one side of the perforator(s).

Optionally, a drug patch system 100, illustrated in FIG. 10, includes a drug reservoir 101, containing a second drug that may be the same as or different from the first drug, that is located above and adjacent to the SSP perforator array 102 and that has an independently controlled reservoir drug delivery system 103. The drug patch system 100 preferably includes a backing film 104 that surrounds the drug reservoir 101 and includes an annular adhesive region 105 (basal layer, best illustrated in FIG. 3) that surrounds and seals off the SSP skin perforation region 106. A plastic release liner 107 is peeled off before skin perforation and protects an SSP system until the liner is peeled off.

In a preferred embodiment, the reservoir in a patch system contains a drug and optionally contains a chemical enhancer in a liquid reservoir, a skin anti-irritant, an anti-infection chemical and/or other chemicals in liquid form. The chemical enhancer may be a fatty alcohol, an acid, an ester, a surfactant, a macrocyclic, a terpene, a phospholipid, a pyrrolidone, an amide or an amino acid. More particularly, a

chemical enhancer may be drawn from among alkyl alcohol, alpha bisabolol, decyl alcohol, dexpanthenol, dodecanol, ethylene glycol, fatty alcohols, glycerol, hexadecanol, isopropanol, octadecanol, tetrahydrofurfuryl alcohol, trichloroethanol, trifluoroethanol, alkyl acetamide, crotamiton, lauryl diethanolamide, toluamide, dimethyl acetamide, dimethyl formide, formamide, nicotinamide, acyl-amino-acids, alanine, arginine, proline, serine, aspartic acid, cysteine, glutamic acid, glycine, valine, leucine, isoleucine, protein aprotinin, azone, essential oils, such as carvone, cineole, eucalyptol, eugenol, methol, methone, terpene fatty acids, such as carboxyl acid, capric acid, diisopropyladipate, isopropyl myristate (IPM), isostearic acid, glyceryl monolaurate (GML), glycerol monooleate (GMO), lactic acid, linoleic acid, lauric acid, methyl laurate, methyl myristate, oleic acid, polyethylene glycol monolaurate, sorbitan monooleate (SMO), sucrose cocoate, sucrose monolaurate, sucrose monooleate, triglyceride, macrocyclic enhancers, such as cyclodextrin, cyclopentadecanone and cyclopentadecanolide, phospholipids, phospholipid/phosphate enhancers, such as dialkylphosphate, lecithin, dioxane, dioxolane, alkylsulfones, alkylsulfones, cetyl ether, cyclic dimethylsiloxane, decamethyltetrasiloxane, dialkyl sulfoxides, dimethylsulfoxide, decylmethylsulfoxide, hexamethyldisiloxane, methyl octylsulfoxide, alkyl ammonium bromide, benzyl nicotinate, butylazocyclopentane, capsaicin, calcium thioglycolate, cyclic amine, diethyl sebacate, dimethylamino acetate, ethylene glycol monoethyl ether, imidazole, methylorthoformate, oxazoline, proline, urea, urethane, macrocyclis, amines, alkyl pyrrolidones, N-methyl pyrrolidone, ethyl pyrrolidone, pyrrolidone, hydroxymethyl pyrrolidone, hexyl pyrrolidone, lauryl pyrrolidone, pyrrolidone-carboxylic acid, lauryl pyrrolidone carboxylic acid, pyroglutamic acid, sodium dedecyl sulfate, sodium deoxycholate, sodium lauryl sulfate, sorbitan monopalmitate, sorbitan trioleate, soybean casein, terpenes, piperazine derivatives, sodium traurocholate, liposome, bisbolol, dithiothreitol and vitamin E ( $\alpha$ -tocopherol).

FIGS. 11A/11B/11C are sectional side views illustrating a preferred embodiment of an SSP patch insertion process in a transdermal application. In FIG. 11A, adhesive in a basal layer 111 of an SSP patch 110 is applied to the skin 112 to hold the patch against the skin. At this point, the perforators 113 are displaced from the skin 112. In FIG. 11B, a plunger or other mechanism 114 is activated to move the perforators 113 into contact with the skin 112, to penetrate the stratum corneum and to enter the epidermis or dermis. In FIG. 11C, the perforators 113 and a basal layer 115 remain in contact with the skin 112. In a preferred embodiment, drug molecules in a reservoir within the upper reservoir of the SSP patch system flow through the channel created by a fully or partially dissolved SSP perforator and into the epidermis. The drug molecules then diffuse into the dermis for local treatment or for transport through the body.

An SSP patch system preferably includes a reservoir containing a liquid or gel form of the second drug and one or more perforators extending from at least a part of the reservoir's surface. The SSP perforators associated with the patch system penetrate the stratum corneum of the skin to enhance percutaneous drug administration and to provide prompt drug delivery and/or prompt drug cut off. In the patch system, the SSP perforators and the reservoir can be constructed as a single unit or as separate units.

The patch reservoir is intended to provide sustained, controllable delivery of a liquid or semi-liquid (second) drug into or across a biological barrier so that diffusion channels are created and remain open after insertion and dissolution

of an SSP perforator (matrix plus drug). The size, shape, composition and areal density of SSP perforators affect the drug release rate through the skin channels. Alternatively, other control mechanisms such as iontophoresis, sonophoresis, heating components and mechanical vibration forces can accelerate, decelerate or otherwise control drug transport through the stratum corneum.

An SSP patch system is applied to the skin so that one or more SSP perforators penetrate through the stratum corneum, into the epidermis or into the dermis depending on the application. In a preferred embodiment, drug molecules in a reservoir in an SSP patch system flow through the channel created by a fully or partially dissolved SSP perforator and into the epidermis or dermis. The drug molecules diffuse into the dermis for local treatment or for transport through the body.

An SSP system can transport therapeutic and/or prophylactic agents, including drugs and vaccine and other bioactive molecules, across skin and other tissues. An SSP device permits drug delivery and access to body fluids across skin or other tissue barriers, with minimal damage, pain and/or irritation at the tissue. In drug delivery applications, an SSP perforator optionally is primarily composed of an active drug and a dissolving or swelling solid matrix depending on a desired drug profile. The SSP system acts as immediate drug source and as a channel creator for subsequent drug delivery through skin. In a diagnostic application, an SSP perforator contains no drug and is composed substantially entirely of a fast-dissolving, biologically inactive solid or a dissolvable or swellable matrix for creating and maintaining the channels. Depending on the application, an osmotically active or anti-irritant compound can have a beneficial effect. In some diagnostic applications and SSP perforator can include or consist of sensor materials that react to presence of specific analytes.

A primary function of a basal layer in an SSP system with reservoir to separate the drug reservoir and to serve as a transport bridge between the reservoir and the remainder of the system. The basal layer material can be same as the solid matrix material, or may be a different material, depending on the application. In an SSP system without reservoir, the basal layer can be laminated with one or more additional layers or materials for controlled release. The outermost basal layer can act as an impermeable backing film to protect against any virus or bacterium that might otherwise invade the skin perforation region. In order to avoid back diffusion from other parts of the SSP system, this layer should have low drug solubility. Where additional and sustained drug release is required, the basal layer can be constructed to contain more of a drug or to provide a conduit to a secondary reservoir. It is useful to have anti-virus and/or anti-bacterial protection in the basal layer to suppress infection. In order to vary or control the drug delivery rate, an external physical enhancement system, using iontophoresis, or sonophoresis, piezoelectric response or a similar response, can be provided as part of a basal layer and/or an overlay layer.

FIG. 12A illustrates a simple design of an SSP patch 120A, including a basal layer 121 including a backing and an array of one or more perforators 122 located adjacent to the skin 123. Active ingredients (drug or drug solid solution) are contained in the perforator. The basal layer can have different thicknesses but is most often an impermeable backing layer. This design is ideal for potent drug delivery, for administering small doses or for instant drug delivery.

FIG. 12B illustrates another design of an SSP patch 120B, including an array of perforators 122 and a basal layer 124 that is porous and optionally serves as a drug reservoir.

Active ingredients are contained in the perforator and in the basal layer. The basal layer 124 can have different composition from the SSP perforator(s) outermost layer but is most often an impermeable backing layer. This design is also ideal for potent drug delivery, for administrating small doses systemically, or for topical applications.

FIG. 12C illustrates a more complex design of an SSP patch 120C. Active ingredients are contained in the perforator and in the reservoir. A top portion of the basal layer 126 contains a drug reservoir patch 125. A first set of perforators 122-1 is oriented to penetrate the stratum corneum of the skin 123, and a second set of perforators 122-2 is oppositely oriented to penetrate a membrane that surrounds or contains fluid in the reservoir patch 125. The reservoir patch 125 can be applied after SSP system application or can be combined with SSP layers. The reservoir can have a variety of composition or formulation depending on targeted drug release profile.

FIGS. 12D and 12E illustrate other designs, 120D and 120E, of SSP patch systems modified from FIGS. 12B and 12C, respectively. The perforator does not contain any drug but does include a dissolving matrix; active ingredients are contained in the basal layer and/or reservoir only. Depending on the drug solubility and concentration, drug release from the basal layer can be controlled. The systems shown in FIGS. 12D and 12E are used primarily for diagnostic purposes and for sustained drug release applications, respectively.

FIG. 12F illustrates use of swellable materials as part of an SSP patch system 120F, optionally with no drug(s) included in the perforator solid matrix. This design extends skin channel openings for a longer (or shorter) time interval and extends the duration of drug delivery or is used for diagnostic applications.

Any drug or other bioactive agent can be delivered using the SSP system. Delivered drugs can be can be proteins, peptides, DNA, genes, polysaccharides, and synthetic organic and inorganic compounds. Representative agents include, but are not limited to, anti-infectives, hormones, growth regulators, drugs regulating cardiac action or blood flow, and drugs for pain control. The drug can be for local treatment or for regional or systemic therapy. The following are representative protein drug examples dose per injection they are used to treat:

$\alpha$ -interferon	11–100 $\mu$ gm
$\beta$ -interferon for multiple sclerosis	22–44 $\mu$ gm
Erythropoetin for anemia	10–30 $\mu$ gm
Follicle stimulating hormone (FSH)	5–30 $\mu$ gm
Granulocyte Colony Stimulating Factor (G-CSF)	9–15 $\mu$ gm
Granulocyte Macrophage Colony Stimulating Factor	250 $\mu$ gm
Human chorionic gonadotropin	30–300 $\mu$ gm
Leutinizing hormone	2–30 $\mu$ gm
Salmon Calcitonin	25–50 $\mu$ gm
Glucagon	1 mgm
GNRH antagonist	2 mgm
Insulin	0.75–1.5 mgm
Human Growth Hormone (GHD)	0.25–1.5 mgm
Human Growth Hormone (AIDS)	6 mgm
Testosterone	5–10 mgm
Lidocaine	2–5 percent
Diclofenac Sodium	100 200 mgm
Oxybutynin	5–15 mgm
Ketoprofen	75–200 mgm
Alemdronate	10 mgm
Enalapril Maleate	10–40 mgm
Phenylpropanolamine HCl	75 mgm

-continued

Cromolyn sodium	3.2–10 mgm
Isotretinoin	0.5–2 mgm/Kgm
Oxytocin	1–2 unit/min/iv
Paroxetine HCl	20 mgm
Flurbiprofen	100 mgm
Sertaline	50 mgm
Venlafaxine	75 mgm
Leuprolide	0.125–0.25 mgm
Risperidone	4–6 mgm
Galanthamine hydrobromide	16–24 mgm
Enoxaprin, anticoagulant	
Etanercept, rheumatoid arthritis	
Fentanyl, postoperative and chronic pain	
Filgrastin, low white blood cells from chemotherapy	
Heparin, anticoagulant	
Parathyroid hormone (PTH)	
Somatropin, growth hormone	
Sumatriptan, migraine headaches	
Morphine	
Opiate anti-arthritis.	

Many drugs can be delivered at a variety of therapeutic rates, controlled by varying a number of design factors including: dimensions of the SSP, dissolving rate of the matrix, number of SSP perforators, size of the SSP patch, size and composition of the reservoir, and frequency of using the device. For example, devices designed to deliver drug at high rates might have a more active drug loaded SSP and/or a faster dissolving matrix. For sustained drug release, fewer SSP perforators and/or use of a slow(er) dissolving solid matrix are useful. The SSP patch can be applied to the skin or other tissue to deliver drugs continuously or intermittently or at a varying rate, for time intervals ranging from a few seconds to several hours or days. Most applications of SSP drug transdermal delivery would target the epidermis, although delivery into blood stream directly is available by extending the penetration length of an SSP patch.

The SSP patch systems disclosed herein are also useful for controlling transport across tissues other than skin. For example, an SSP patch can be inserted into a patient's eye to control or correct conjunctiva, sclera, and/or cornea problems, to facilitate delivery of drugs into the eye with a slow moving actuator. Similarly, an SSP system, inserted into the eye, could facilitate transport of fluid out of the eye, which may be of benefit for treatment of glaucoma. An SSP patch can also be inserted into the buccal (oral), nasal or vaginal regions or inside a tissue with the aid of a laparoscope or into other accessible mucosal layers to facilitate transport into or across those tissues. For example, a drug may be delivered across the buccal mucosal for local treatment in the mouth. As another example, SSP systems may be used internally within the body on, for example, the lining of the gastrointestinal tract to facilitate uptake of orally-ingested drugs or at the lining of blood vessels to facilitate penetration of drugs into the vessel wall. In this case of internal tissue application, use of bio-adhesive SSP material can be an additional benefit.

Another important application is vaccination. The skin is an ideal site for effective vaccine delivery because it contains a network of immune cells, such as Langerhans cells. There are several advantages of SSP technology in delivering antigenic compounds to the epidermis, which has a high density of immune cells and consequently triggers the immune system more effectively. An SSP system is a practical design for developing multivalent vaccines easily and

11

is expected to provide more stability than use of a liquid for transport and storage of drugs. The following vaccines can be delivered, among others.

- Hepatitis B
- HIV vaccine
- Influenza
- Diphtheria
- Tetanus
- Pertussis
- Lyme disease
- Rabies
- Pneumococcus
- Yellow fever
- Cholera
- Vaccinia
- Tuberculosis
- Rubella
- Measles
- Mumps
- Rotavirus
- Botulinum
- Herpes virus
- Other DNA vaccines

Another area of applications is cosmeceutical. An SSP system including a patch can deliver botox toxin or a hydroxyacid more efficiently and safely to remove or reduce wrinkle formation and skin aging. The system is also useful for treating lesions or abnormal skin features, such as pimples, corns, warts, calluses, bunions, actinic keratoses and hard hyperkeratotic skin, which is often found on the face, arms, legs or feet. An SSP system is also useful as a food patch to deliver essential amino acids, fats and vitamins. A food patch is often used in emergencies.

What is claimed is:

1. A system for delivering a substance into tissue comprising:
  - a patch including
    - a basal layer having a first side and a second side, and
    - a plurality of micro-perforators projecting from the first side of the basal layer and formed from a solid matrix material without channels or passageways that are dissolved by a solvent in the tissue to form channels for delivering a substance into the tissue by diffusion, wherein the matrix material comprises a polymer or a carbohydrate derivative; and
  - a reservoir, including the solvent that dissolves the solid matrix material upon contact with the solvent over a time interval of between a few tens of seconds and a few hours after the micro-perforators have been inserted into a patient's body, wherein the reservoir can be attached to the second side of the basal layer.

12

2. The system of claim 1 wherein the matrix material comprises the substance.
3. The system of claim 1 wherein the reservoir further includes the substance.
4. The system of claim 3 wherein the matrix material comprises a second substance.
5. The system of claim 1 wherein the substance is a drug.
6. The system of claim 1 wherein the matrix material comprises a polymer.
7. The system of claim 1 wherein the matrix material comprises a carbohydrate derivative.
8. The system of claim 1 wherein the matrix material is water-soluble.
9. The system of claim 1 wherein the reservoir is integrally attached to the second side of the basal layer.
10. A method for delivering a substance into tissue comprising:
  - forming a plurality of channels into the tissue by
    - affixing a patch including a basal layer having a first side and a second side, and a plurality of micro-perforators projecting from the first side of the basal layer and formed of a solid matrix material without channels or passageways into the tissue, wherein the matrix material comprises a polymer or a carbohydrate derivative, and
    - dissolving the solid matrix material to form the plurality of channels, wherein the matrix material dissolves over a time interval of between a few tens of seconds and a few hours after the micro-perforators have been inserted into a patient's body, wherein dissolving the matrix material comprises attaching to the patch a reservoir of a solvent effective to dissolve the matrix material upon contact with the solvent, and delivering the solvent from the reservoir to the micro-perforators; and
    - delivering the substance through the plurality of channels by diffusion.
11. The method of claim 10 wherein dissolving the matrix material is effective to deliver a second substance into the tissue.
12. The method of claim 10 wherein the method further comprises removing the basal layer from the tissue after the micro-perforators have dissolved.
13. The method of claim 10 that further comprises activating a perforation activation mechanism that is effective to insert the plurality of micro-perforators to a predetermined distance into the tissue.

\* \* \* \* \*